



# 东莞伟博镍氢电池规格书

VICTORY NIMH BATTERIES SPECIFICATIONS

Model No.: 60D10000P 1.2V

制定(PREPARED BY): 康英春 日期 DATE: 2011-1-04

审核(CHECKED BY): 洪春华 日期 DATE: 2011-1-04

批准(APPROVED BY): 高敬涛 日期 DATE: 2011-1-04

地址 Add: 中国东莞市黄江镇田心村蝴蝶2路

电话 Tel:86-769-88219558

传真 Fax:86-769-82605811

网址 Http:www.victorybattery.com.cn





型号(Type) : 60D1000P

单颗电池规格 Specifications of single cell

标称电压 Nominal voltage		1.2V	
容量 Capacity		0.2C 放电 Discharge	3C 放电 Discharge
	最小 Minimum	300mAh	18.5min
	典型 Typical	315mAh	19.5min
尺寸 Dimensions	直径 Diameter	mm	
	高 Height	32.4 <sup>±0.2</sup>	
大约重量 Weight(Approximately)		克 gram	
		180	
电阻 Internal Impedance At 1000 Hz		4.5mΩ(Max) (充电后 After Charge)	
充电 Charge	标准 Standard	1000mA(0.1C)×15hrs	
	快速 Rapid	5000mA(0.5C)×2.1hrs	
环境温度 Ambient temperature	充电 Charge	标准 standard	0°C to 45°C
		快速 Rapid	0°C to 40°C
	放电 Discharge	-20°C to 50°C	
	贮藏 Storage	-20°C to 40°C	

典型特征 Typical characteristics

标准充电特征 Standard charge

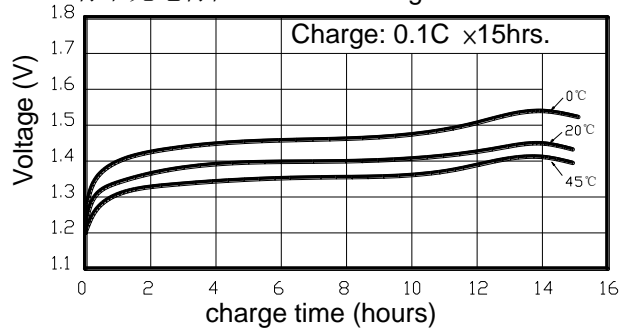

快速充电特征 Rapid charge

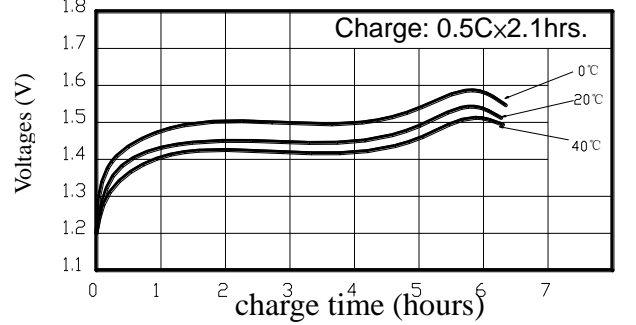

放电特征 Discharge characteristics

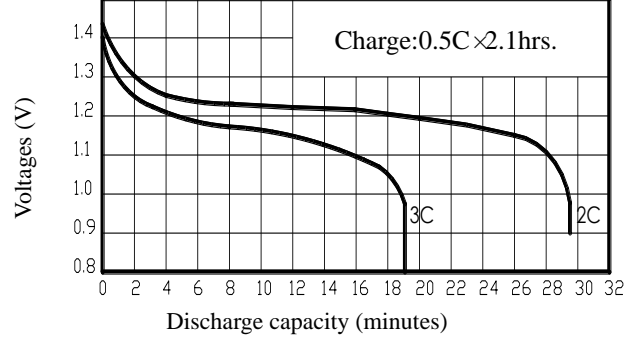

寿命特征图 Cycle life characteristics

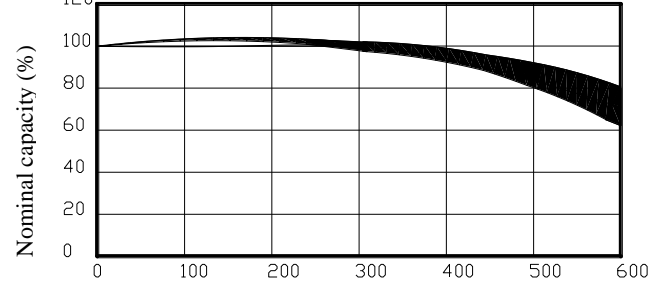

Ni-MH 圆柱型电池在不同的温度荷电保持曲线图  
Charge retention curves of Ni-MH cylindrical cell At various storage temperatures

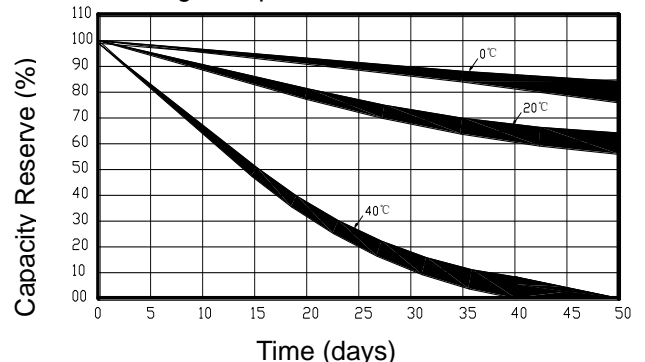

单颗电池尺寸包括 PVC (Dimensions with tube)

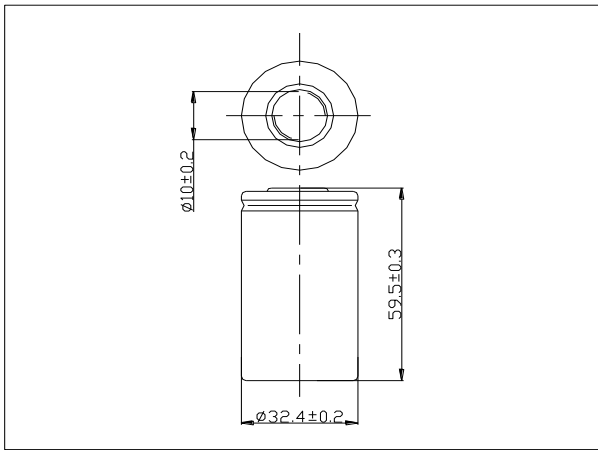

备注 Note:

1. 标称容量是指 20°C 时 0.2C 放电容量  
Nominal capacity, rated at 0.2C 20°C.
2. 重量作为参考  
Weight and internal impedance are For reference.
3. 寿命测试依照 IEC 标准  
Standard according as IEC of test cycle life。



### 1. 序言 PREFACE

此规格书适用于东莞市伟博电池科技有限公司的镍氢可充电电池产品

The specification is suitable for the performance of NI-MH rechargeable battery produced by the DONGGUAN VICTORY BATTERY TECHNOLOGY CO., LTD.

### 2. 型号 MODEL

60D10000P 1.2V

### 3. 外观 APPEARANCE

没有类似变色、污点、电解液泄漏和零伏现象。

There shall be no such details as discoloration or electrolyte leakage or 0 voltage.

### 4. 定额 RATINGS

种类 Description	单位 Unit	规格 Specification	条件 Condition
标称电压 Nominal Voltage	V	1.2V	单位颗 Unit cell
典型容量 Typical Capacity	min	19.5	3C 放电到 0.8V Discharge at 3C to 0.8V
标称容量 Nominal Capacity	mAh	10000	标准充放电 Standard Charge/Discharge
最小容量 Minimum Capacity	min	18.5	3C 放电到 0.8V Discharge at 3C to 0.8V
标准充电 Standard Charge	mA	1000(0.1C)	Ta=0~40℃ (see note)
	hour	15	
快速充电 Fast Charge	mA	2000(0.2C) 用充电控制 with charge termination control	-ΔV=10mV/ cell Timer cutoff=105%input capacity Temp. cutoff=40~45℃ dT/dt=0.8℃/min(0.2 to 1.0C); 0.8~1℃/min(1C)
	hour	6.5 approx.(0.2C)	
涓流充电 Trickle Charge	mA	500(0.05C)~1000(0.1C)	Ta=0~40℃ (see note 1)
最大放电电流 Maximum Discharging Current	A	30(Continuous) 50(Momentary)	Ta =0~50℃ 0.8v/cell cut off
贮藏温度 Storage Temperature	℃	-20~+25(within 1 year) -20~+30(within 3 month) -20~+40(within 1 month) -20~+50(within 1 week)	*
典型重量 Typical Weight	g	180approx	*



## 5. 性能测试 PERFORMANCE

在进行下列各项测试前每颗电池应用 0.2C 放至 1.0V。如果没有特别规定，测试应在电池交付 1 个月内按以下各项条件进行：

Before proceed the following tests, the cells should be discharged at 0.2C to 1.0V cutoff. Unless otherwise stated, tests should be done within one month of delivery under the following conditions:

环境温度 Ambient temperature:  $20^{\circ}\text{C} \pm 5^{\circ}\text{C}$

相对湿度 Relative Humidity:  $65 \pm 20\%$

注意标准充放电为 Note Standard Charge/Discharge Conditions:

充电 Charge:  $1000 \text{ mA}(0.1\text{C}) \times 15\text{hrs}$

放电 Discharge:  $2000\text{mA}(0.2\text{C})$  to 1.0V/cell

测试项目 Test	单位 Unit	规格 Specification	条件 Condition	备注 Remarks
容量 Capacity	min	$\geq 300$	0.2C 放电到 1.0V Discharge at 0.2C to 1.0V	允许循环 3 次 Up to 3 cycles are allowed
开路电压 Open circuit Voltage (OCV)	V	$\geq 1.32$	标准充电后 1 个小时内 Within 1 hr after standard charge	单位颗 Unit cell
内阻 Internal Impedance (Ri)	m $\Omega$	$\leq 4.5$	充满电后用 1kHz 测试 Upon fully charge at 1kHz	*
低温放电测试 Low Temperature Discharge	min	$\geq 270$	标准充电后贮藏在 $0 \pm 2^{\circ}\text{C}$ 环境中 24 小时 然后用 0.2C 放电 Standard Charge, Storage: 24hrs at $0 \pm 2^{\circ}\text{C}$ 0.2C discharge at $0 \pm 2^{\circ}\text{C}$	1.0V/cell Cut-off
过充测试 Overcharge	N/A	没有显著的变型和漏液 No conspicuous deformation and/or leakage	0.1C 充电 48 小时 0.1C charge for 48hrs	*
自放电 Charge reserve	min	$\geq 195\text{min}$	标准充满电后贮藏 28 天, 标准 0.2C 放电 Standard charge Storage: 28 days Standard discharge (0.2C)	1.0V/cell Cut-off
IEC 寿命测试 IEC Cycle Life Test	Cycle	$\geq 500$	IEC61951-2(2003)7.4.1.1	*
高湿度测试 Humidity	N/A	不漏液 No leakage	标准充电后贮藏在温度 $33 \pm 3^{\circ}\text{C}$ 相对湿度 80 $\pm 5\%$ 环境 14 天 Standard charged, stand for 14 days at $33 \pm 3^{\circ}\text{C}$ and 80 $\pm 5\%$ of relative humidity	*



短路测试 External Short Circuit	N/A	不着火不爆炸 No fire and no explosion	标准充电后, 在 20℃±5 环境中用超过 0.75mm <sup>2</sup> 金属丝将单颗电池短路至电池恢复到常温。 After standard charge, short-circuit the cell at 20℃±5℃ until the cell temperature returns to ambient temperature.(cross section of the wire or connector should be more than 0.75mm <sup>2</sup> )	*
安全阀测试 Safety Device Operation	N/A	不爆炸 No explosion	将电池用 0.2C 强迫放电至 0V 后转用 1C 强迫放电 60 分钟。 Forced discharge at 0.2C to a final voltage of 0V, then the current be increased to 1C and forced discharge continue for 60 min	电池电解液泄漏和电池变型是可接受的。 Leakage of electrolyte and Deformation are acceptable
自由跌落测试 Free falling(drop)	N/A	$\Delta V < 0.02V/cell$ $\Delta Ri < 5\%/cell$	跌落测试前电池用 0.1C 充 15 小时, 搁置 24 小时。从 50CM 高任意方向自由跌落 30MM 厚木板 3 次 Charge at 0.1C for 15hrs, and then leave for 24hrs, check battery before / after drop Height: 50 cm Thickness of wooden board: 30mm Direction is not specified Test for 3 times	*

备注 Notes:

1. Ta: 环境温度  
Ta: Ambient Temperature
2. 充电时间仅供参考。  
Approximate charge time from discharged state, for reference only.
3. 请每隔 3 个月按下面方法激活电池一次:

0.1C 充电 15 小时, 休息 10 分钟, 然后用 0.2C 放电至每颗电池 1.0V, 休息 10 分钟, 0.2C 充电 150 分钟。

please activate the battery once every 3 months according to the following method:

Charge at 0.1C for 15 hrs, rest 10 min, then discharge with 0.2C to 1.0V/cell, rest 10 min, then charge at 0.2C to 150min.

**6. 注意事项 PRECAUTIONS TO ENSURE THE SAFETY ON BANDING BATTERY**

1. 电池在使用前必须充电。  
Batteries should be charged prior to use.
2. 在使用新电池前, 或者长期存放后第一次使用电池, 在使用前请将电池充满电。  
.When using a new battery for the first time or after long term storage, please fully charge the battery before use.
3. 充电方法请参考我们的技术手册。  
For charging methods please reference to our technical handbook.
4. 使用 Ni-Cd 或 Ni-MH 专用充电器。  
Use the correct charger for Ni-Cd or Ni-MH batteries.
5. 不要对电池进行反充电。  
Do not reverse charge batteries.



6. 不要将电池短路,那可能永久的损坏电池。

Do not short circuit batteries, permanent damage to batteries may result.

7. 不要燃烧或毁坏电池, 可能导致有毒气体释放或爆炸.

Do not incinerate or mutilate batteries, may burst or release toxic material.

8. 不要直接对电池进行焊接.

Do not solder directly to cells or batteries.

9. 不要让电池处于不利环境中, 比如极端的温度, 深度循环, 或者经常过充/过放电

Do not subject batteries to adverse condition such as extreme temperature, deep cycling and excessive overcharge/overdischarge.

10. 将电池贮存在阴凉干燥处.

Store batteries in a cool dry place.

11. 不要将 VB power 电池与其他品牌的电池或者不同种类的电池, 比如碱性锌电池混用.

Do not mix VB power batteries with other battery brands or batteries of a different chemistry such as alkaline and zinc carbon.

12. 不要将新旧电池混用, 可能会导致过放电.

Do not mix new batteries in use with semi-used batteries, overdischarge may occur.

13. 禁止将电池在密闭环境中使用. 需要保持通风; 否则电池可能产生氢气,导致爆炸.

Avoid batteries being used in an airtight compartment. Ventilation should be provided inside the battery compartment; otherwise batteries may generate hydrogen gas, which could cause an explosion if exposed to an ignition source.

14. 当把电池放入充电器中时, 注意保证极性正确.

When connecting a battery pack to a charger, ensure correct polarity.

15. 如果出现噪音, 温度异常, 或者漏液, 请停止使用.

If find any noise, excessive temperature or leakage from a battery, please stop its use.

16. 如果电池发烫, 请勿触摸, 直至冷却.

When the battery is hot, please do not touch it and handle it, until it has cooled down.

17. 不要把电池 (电池组) 的外套去除.

Do not remove the outer sleeve from a battery pack nor cut into its housing.

18. 电池使用时发现功率下降, 请关闭用电器开关以防止电池过放.

When find battery power down during use, please switch off the device to avoid overdischarge.

19. 当电池不使用时, 请把它从装置上取下.

When not using a battery, disconnect it from the device.

20. 取下电池组时, 用手抓住插头而不是拉线.

Unplug a battery by holding the connector itself and not by pulling at its cord.

21. 电池使用后, 如果电池发热, 再次充电前, 请在通风环境中冷却.

After use, if the battery is hot, before recharging it, allow it to cool in a well-ventilated place out of direct sunlight.

22. 不要将电池放入水中或海水中.

Never put a battery into water or seawater.



23. 经过长时间存放, 电池应每三个月进行一次充放电.

During long term storage, battery should be charged and discharged once every half a year.

24. 不要尝试分离, 挤压, 撞击电池, 电池会发热或起火. 电池中的碱液对皮肤和眼睛有害, 而且会损伤衣服.

Do not attempt to take batteries apart or subject them to pressure or impact. Heat may be generated or fire may result. The alkaline electrolyte is harmful to eyes and skin, and it may damage clothing upon contact.

25. 要使电池远离儿童. 如发现吞食, 立即联系医生.

Keep away from children. If swallowed, contact a physician at once.

7. 补充: IEC61951 4.4 循环寿命条款

在进行循环测试前, 电池应 0.2 1<sub>t</sub>A 放电至 1.0V.

然后进行以下的测试, 不考虑电池的型号, 在环境温度 20°C ± 5°C. 充放电必须保持恒流, 条件如表 5 中描述. 在测试过程中注意预防电池温度高于 35°C, 如果需要的话对电池进行强制空气制冷.

注意-实际上是电池的温度, 而不是环境温度决定电池的性能.

表 5-循环测试

循环数	充电	搁置	放电
1	0.1C <sub>t</sub> A for 15 h	None	0.25 C <sub>t</sub> A for 2 h 20 min <sup>2)</sup>
2 to 48	0.25 C <sub>t</sub> A for 3 h 10 min	None	0.25 C <sub>t</sub> A for 2 h 20 min <sup>2)</sup>
49	0.25 C <sub>t</sub> A for 3 h 10 min	None	0.25 C <sub>t</sub> A to 1.0V
50	0.1 C <sub>t</sub> A for 15h	1h to 4h	0.2C <sub>5</sub> A to 1.0V <sup>1)</sup>

- 在做完第 50 个循环后允许电池搁置一定的时间, 然后再开始第 51 个循环, 同样的程序适用于 100,150,200,250,300,350,400and 450 周.
- 如果电池电压低于 1.0V, 可以终止放电.

重复 1-50 次循环, 直至出现任一个第 50 次循环的放电时间少于 3h 为止, 这时按照第 50 次循环的规定再进行一次循环.

当两这样的连续循环的持续放电时间均少于 3h 时, 寿命测试终止. 实验结束时, 循环次数不得少于 500 次.

Append: IEC61951 4.4 Endurance in cycles

Before the endurance in cycles test, the cell shall be discharged at 0.2 1<sub>t</sub>A to a final voltage of 1.0V/cell. The following endurance test shall then be carried out, irrespective of cell designation, in an ambient temperature of 20°C ± 5°C. Charge and discharge shall be carried out at constant current throughout, using the conditions specified in table 5. Precautions shall be taken to prevent the cell-case temperature from rising above 35°C during the test, by providing a forced air draught if necessary.

NOTE-Actual cell temperature, not the ambient temperature, determines cell performance.

Table 5-Endurance in cycles

Cycle number	Charge	Stand in Charged condition	Discharge
1	0.1C <sub>t</sub> A for 15 h	None	0.25 C <sub>t</sub> A for 2 h 20 min <sup>2)</sup>
2 to 48	0.25 C <sub>t</sub> A for 3 h 10 min	None	0.25 C <sub>t</sub> A for 2 h 20 min <sup>2)</sup>
49	0.25 C <sub>t</sub> A for 3 h 10 min	None	0.25 C <sub>t</sub> A to 1.0V/cell
50	0.1 C <sub>t</sub> A for 15h	1h to 4h	0.2C <sub>5</sub> A to 1.0V/cell

- It is permissible to allow sufficient open-circuit rest time after the completion of discharge at cycle 50, so as to start cycle 51 at an exact two-week interval. A similar procedure may be adopted at cycles 100,150,200,250,300,350,400and 450.
- If cell discharge voltage drops below 1.0V/cell, discharge may be discontinued.

Cycles 1 to 50 shall be repeated until the discharge duration on any 50<sup>th</sup> cycle becomes less than 3h at this stage, a further cycle as specified for cycle 50 shall be carried out.

The endurance test is considered complete when two such successive cycles give a discharge duration less than 3h. The number of cycles obtained when the test is completed shall be not less than 500.

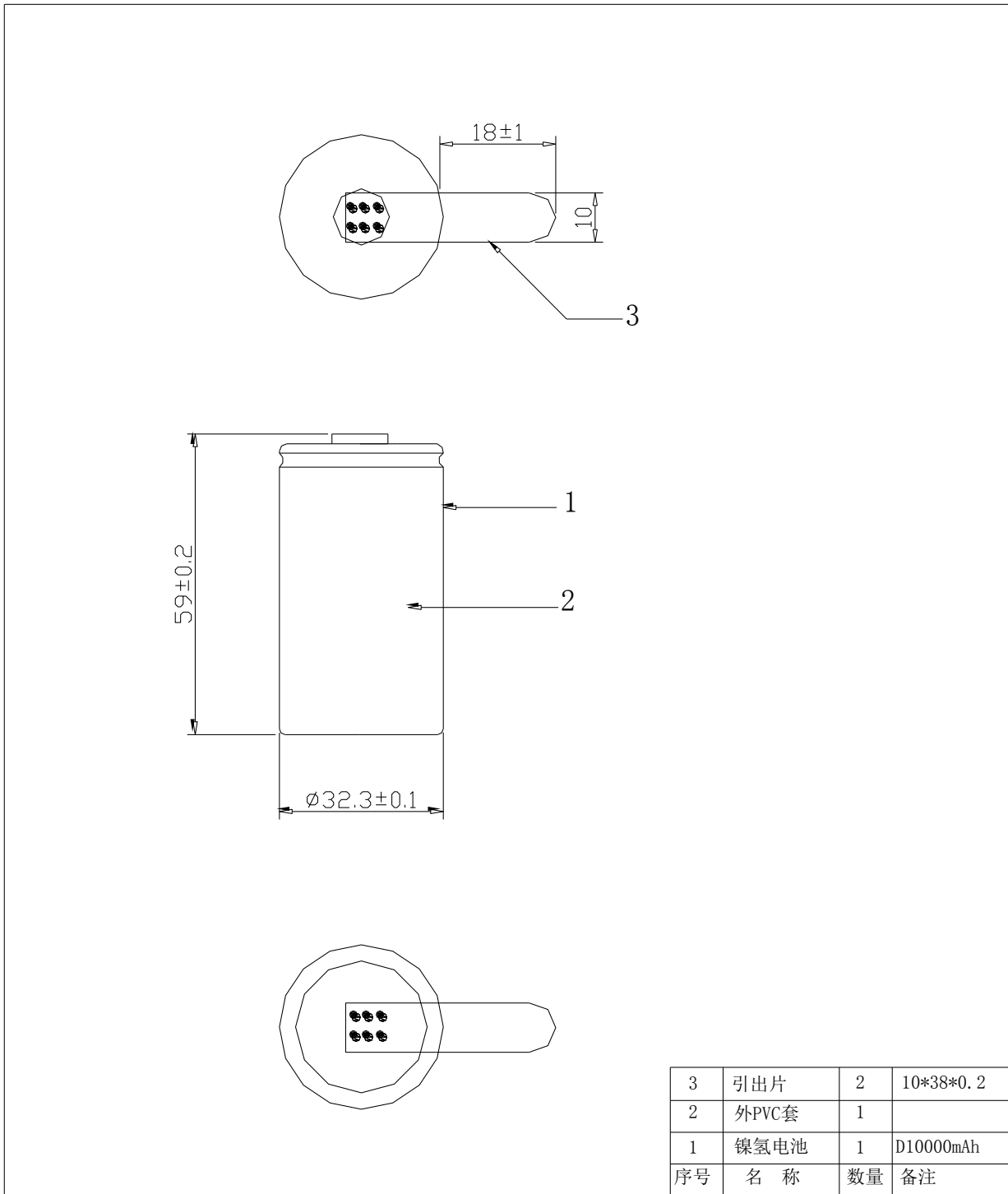

3	引出片	2	10*38*0.2
2	外PVC套	1	
1	镍氢电池	1	D10000mAh
序号	名称	数量	备注

更改标记	数量	更改单号	签名	日期
设计			日期	
制图			日期	
审核			日期	
标准化			日期	
批准			日期	

## 电池组合图

D10000mAh*1			
等级	标记	单位	比例
		mm	
东莞市伟博电池科技有限公司			